



## LG Series Fryer

LG300

ML-136528

LG400

ML-136622

LG500

ML-136643

### - NOTICE -

This Manual is prepared for the use of trained Hobart Service Technicians and should not be used by those not properly qualified.

This manual is not intended to be all encompassing. If you have not attended a Hobart Service School for this product, you should read, in its entirety, the repair procedure you wish to perform to determine if you have the necessary tools, instruments and skills required to perform the procedure. Procedures for which you do not have the necessary tools, instruments and skills should be performed by a trained Hobart Service Technician.

The reproduction, transfer, sale or other use of this manual, without the express written consent of Hobart, is prohibited.

This manual has been provided to you by ITW Food Equipment Group LLC ("ITW FEG") without charge and remains the property of ITW FEG, and by accepting this manual you agree that you will return it to ITW FEG promptly upon its request for such return at any time in the future.

# TABLE OF CONTENTS

SERVICE UPDATES .....	3
SERVICE UPDATES .....	3
TIS DOCUMENT LIST - LG SERIES FRYER .....	3
GENERAL .....	5
INTRODUCTION .....	5
INSTALLATION, OPERATION AND CLEANING .....	5
TOOLS .....	5
SPECIFICATIONS .....	5
REMOVAL AND REPLACEMENT OF PARTS .....	6
COVER PANELS .....	6
BURNERS .....	7
THERMOSTAT .....	7
HIGH LIMIT THERMOSTAT .....	8
THERMOPILE .....	9
PILOT .....	10
PILOT ORIFICE .....	11
COMBINATION VALVE .....	12
FRY TANK .....	13
SERVICE PROCEDURES AND ADJUSTMENTS .....	14
TURNING FRYER OFF .....	14
LIGHTING PILOT .....	14
DRAIN FRYER TANK .....	15
MILLIVOLT CONTROLS TEST .....	15
THERMOSTAT CALIBRATION .....	16
PILOT ADJUSTMENT .....	16
BURNERS, NOZZLES AND ORIFICES .....	17
COMBINATION VALVE REGULATOR ADJUSTMENT .....	18
EXTENDED SHUT-DOWN .....	19
DIAGRAMS .....	20
SCHEMATIC .....	20
WIRING DIAGRAM .....	21
ELECTRICAL OPERATION .....	22
CONTROL SYSTEM DESCRIPTION .....	22
SYSTEM CONDITION QUICK CHECK PROCEDURE .....	22
COMPONENT FUNCTION .....	23
TROUBLESHOOTING .....	24
TROUBLESHOOTING .....	24

# SERVICE UPDATES

## SERVICE UPDATES

### May 2022

- Updated THERMOSTAT CALIBRATION.

### April 2022

- Updated MILLIVOLT CONTROLS TEST.

### NOVEMBER, 2018

- Added TIS Document List.

## TIS DOCUMENT LIST - LG SERIES FRYER

### SERVICE TAB

Document Title	Document Type
LG Series Service Manual	Service Manual

### SERVICE TAB (Multimedia)

Document Title	Document Type
KleenScreen Filtration System User's Guide	Instructions
Repair Flood-Damaged Equipment	Misc
LG Series Electric Fryers	Operator
Fryers, Mobile Filters, Gas & Electric Service Information	Service Instructions
Fundamentals of Gas	Service Instructions
Hobart Fryers with TDI Computer Control Quick Reference Programming Guide	Service Instructions
Hobart Gas Fryers with Drawer Filter System Solid State Controller Kits - Part No. 913012-6 & 913012-7 Installation Instructions	Service Instructions
Vulcan Fryers Part No. 415144-17 & 415144-18 Control Board Instructions	Service Instructions
Rating Plate Locations ON Current Vulcan-Hart/Wolf Range Equipment	Technical Service Bulletin (TSB)
TSB 1037A Hobart to Vulcan "Common" Model Cross Reference List	Technical Service Bulletin (TSB)
TSB 1159 Floor & Battery Fryers (Gas & Electric) - "Continuous Hinge" Door Assembly	Technical Service Bulletin (TSB)
TSB 1254 Gas & Electric fryers - New Door Magnet (Hobart & Vulcan)	Technical Service Bulletin (TSB)
TSB 1301 Onwatch Quicklook 72 for Gas Cooking Equipment	Technical Service Bulletin (TSB)
TSB 1304 Gas Millivolt Controls	Technical Service Bulletin (TSB)
TSB 1324 Solid State Control - Software Revision 3.0 & Higher / Hobart & Vulcan Gas & Electric Fryers	Technical Service Bulletin (TSB)
TSB 1325 Computer Control - Software Revision 3.0 & Higher / Hobart & Vulcan Gas & Electric Fryers	Technical Service Bulletin (TSB)
TSB 1345 Fryer Tank Assembly - Drain Size Change	Technical Service Bulletin (TSB)
TSB 1352 Hobart & Vulcan Gas & Electric Fryers - AFC to NCC Computer Control Conversion Kits	Technical Service Bulletin (TSB)

### PARTS TAB (Multimedia)

Document Title	Document Type
LG Series Parts Catalog	Parts Catalog



# GENERAL

## INTRODUCTION

This manual is applicable only to models listed on the cover page. Procedures in this manual will apply to all models unless specified. Pictures and illustrations can be of any model unless they need to be model specific.

## INSTALLATION, OPERATION AND CLEANING

For detailed installation, operation and cleaning instructions, refer to the Installation & Operation Manual sent with each unit. The manual is also available online at [www.vulcanequipment.com](http://www.vulcanequipment.com).

## TOOLS

### Standard

- Standard set of hand tools.
- VOM with minimum of NFPA-70E CATIII 600V, UL/CSA/TUV listed. Sensitivity of at least 20,000 ohms per volt. Meter leads must also be rated at CAT III 600V.
- Temperature tester (thermocouple type).
- ESD (Electrostatic discharge) Protection Kit.

### Special

- Manometer.

## SPECIFICATIONS

Gas Data		
Model	No. Tubes	BTU/HR
LG300	3	90,000
LG400	4	120,000
LG500	5	150,000

# REMOVAL AND REPLACEMENT OF PARTS

## COVER PANELS

### Door

#### NOTICE

Be prepared to catch door when bottom hinge is removed.

1. Remove door hinge screws while supporting door.

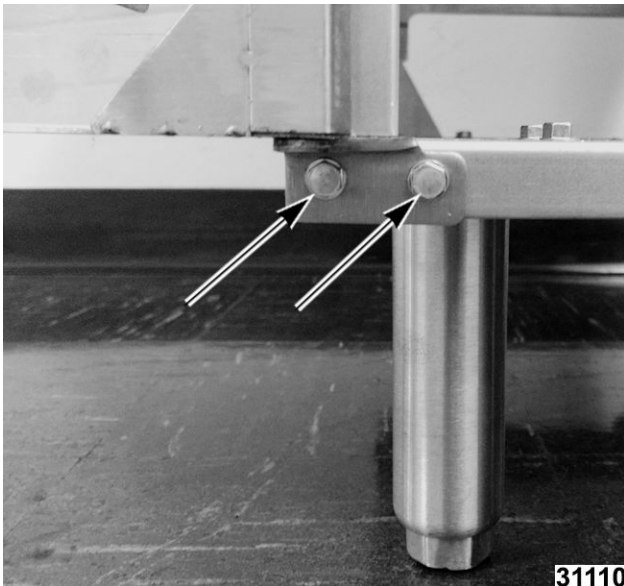

Fig. 1

2. Reverse procedure to install.

### Heat Shield

1. Remove DOOR.
2. Remove heat shield mounting screws.

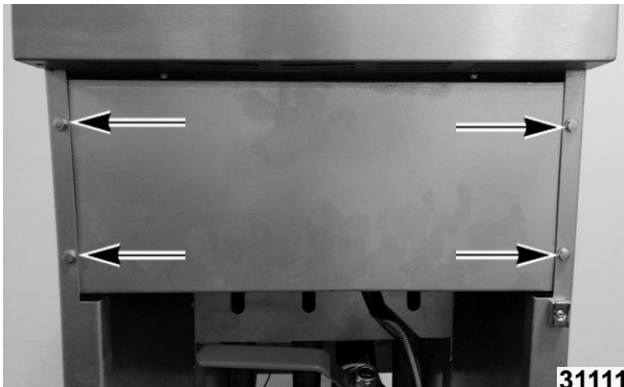

Fig. 2

3. Angle heat shield to remove.



Fig. 3

4. Reverse procedure to install.

### Back Panel

1. Remove rear panel mounting screws.

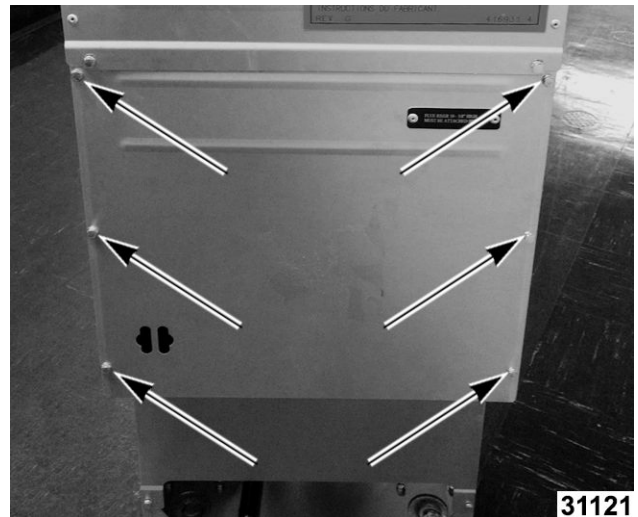

Fig. 4

2. Reverse procedure to install.

### Flue Wrap

1. Remove screws securing flue wrap.



Fig. 5

2. Reverse procedure to install.

### Flue Box

1. Remove FLUE WRAP.
2. Remove screws securing flue box.



Fig. 6

3. Reverse procedure to install.

## BURNERS



### WARNING

Shut off the gas before servicing the unit and follow lockout / tagout procedures.

1. Remove HEAT SHEILD.
2. Loosen mounting bolts at top of burner being removed.

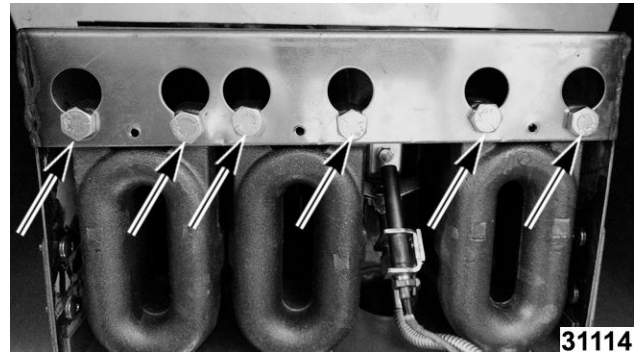

Fig. 7

3. Push up on burner while pulling bottom of burner forward to clear burner nozzle.
4. Reverse procedure to install.

## THERMOSTAT

### WARNING

Oil may be hot when draining fryer tank.



### WARNING

Shut off the gas before servicing the unit and follow lockout / tagout procedures.

1. DRAIN FRYER TANK.

**NOTE:** Steps to remove Heat Shield can be skipped if back of fryer is accessible. Remove BACK PANEL to access thermostat probe packing nut.

2. Remove HEAT SHIELD.
3. Remove LEFT BURNER.
4. Pull thermostat knob (1, Fig. 8) off thermostat shaft.

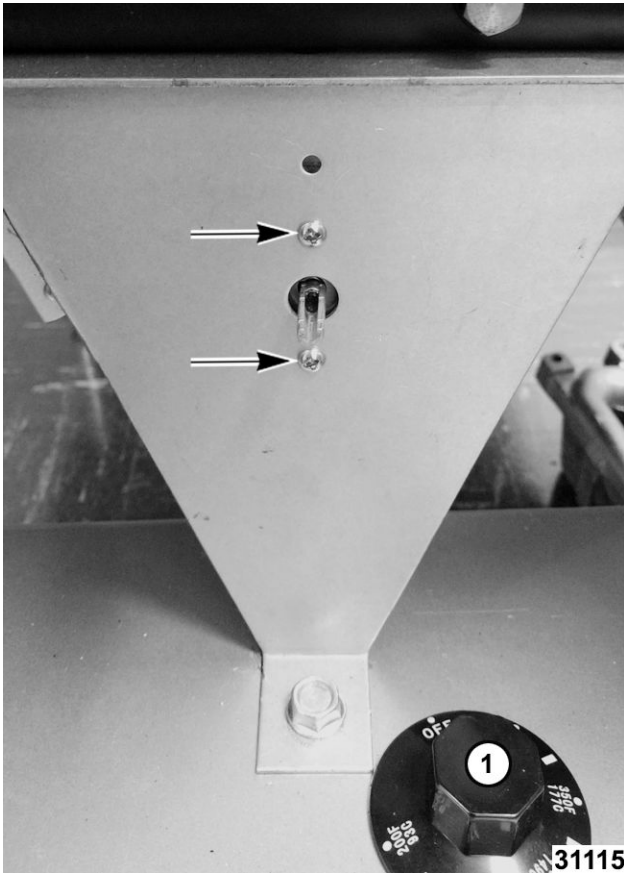

Fig. 8

5. Remove thermostat mounting screws (Fig. 8) and bracket.
6. Note and disconnect thermostat wiring.



Fig. 9

7. Loosen packing nut (1, Fig. 10) and remove holding nut (2, Fig. 10).

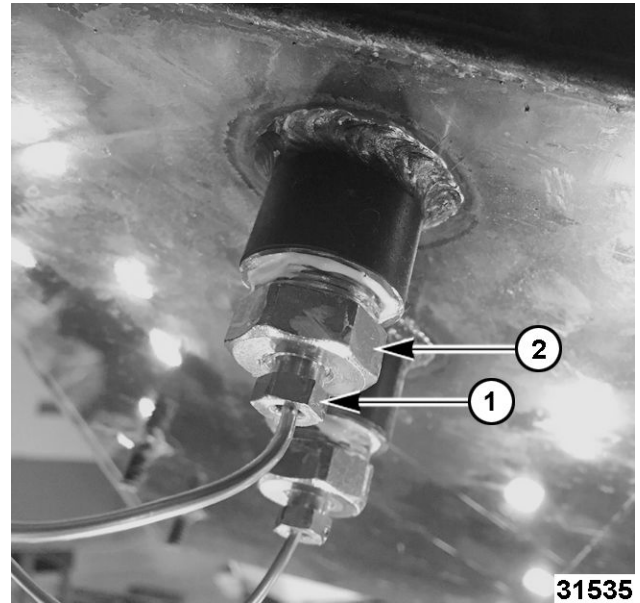

Fig. 10

8. Remove thermostat bulb from clamp.

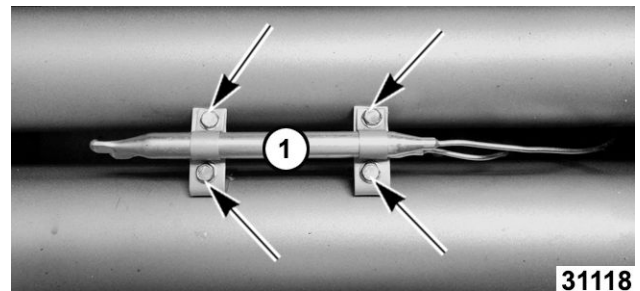

Fig. 11

9. Remove thermostat assembly.
10. Reverse procedure to install.

**NOTICE**

Take care not to kink thermostat capillary when installing. Wrap threads of packing nut with teflon tape to prevent leakage.

**HIGH LIMIT THERMOSTAT**



**WARNING**

Shut off the gas before servicing the unit and follow lockout / tagout procedures.

1. DRAIN FRYER TANK .
2. Remove HEAT SHIELD.
3. Remove LEFT BURNER.
4. Remove high limit mounting bracket.



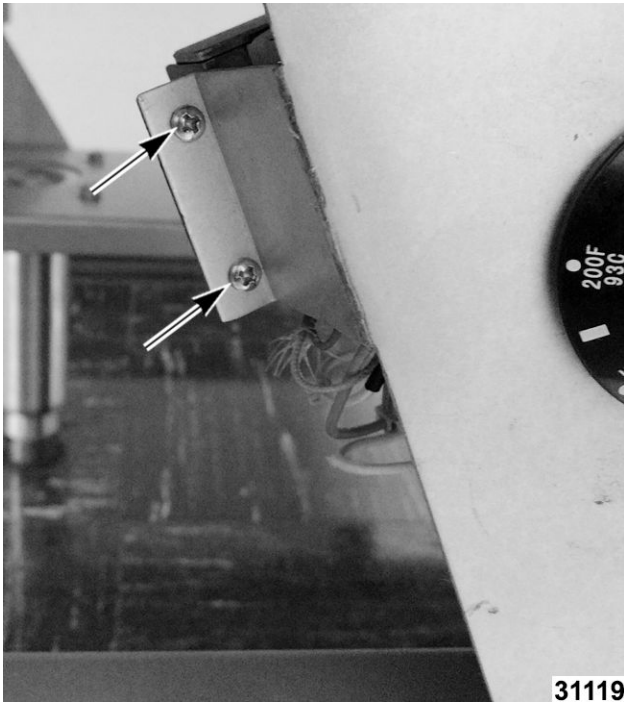

Fig. 12

5. Note wires and disconnect.

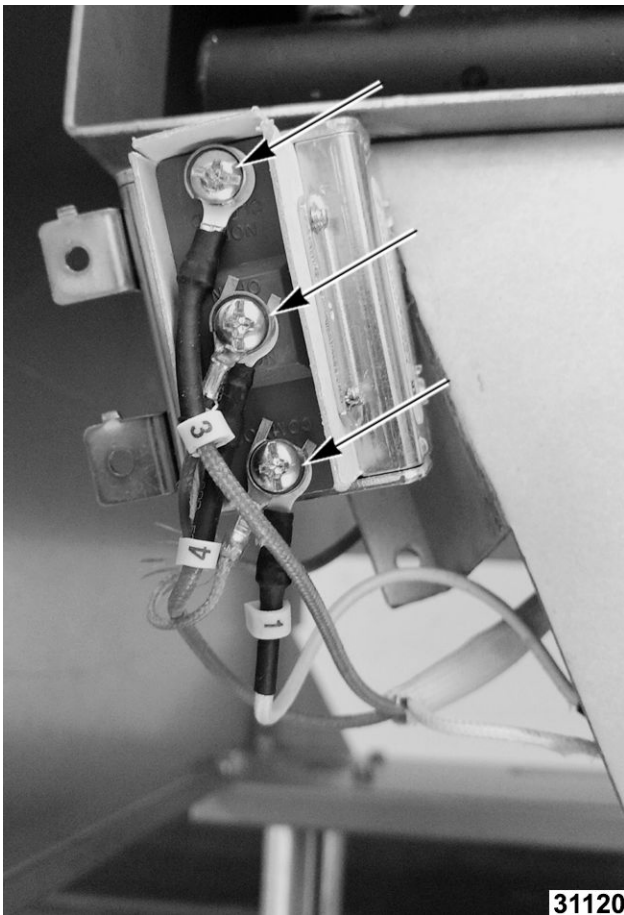

Fig. 13

6. Loosen packing nut (1, Fig. 14) and remove holding nut (2, ).

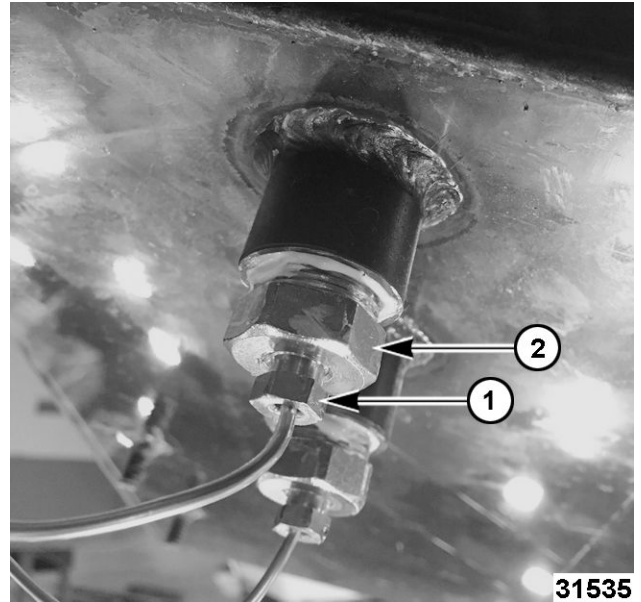

Fig. 14

7. Reverse procedure to install.
8. Check for leaks.

## THERMOPILE



### **⚠ WARNING**

Shut off the gas before servicing the unit and follow lockout / tagout procedures.

### **⚠ WARNING**

All gas joints disturbed during servicing must be checked for leaks. Check with a soap and water solution (bubbles). Do not use an open flame.

1. Remove pilot assembly bracket.

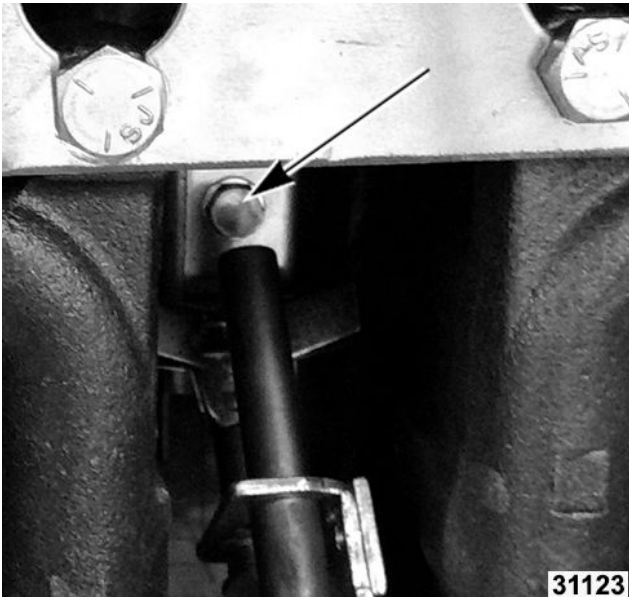

Fig. 15

- Note and disconnect thermopile to high limit switch wiring.

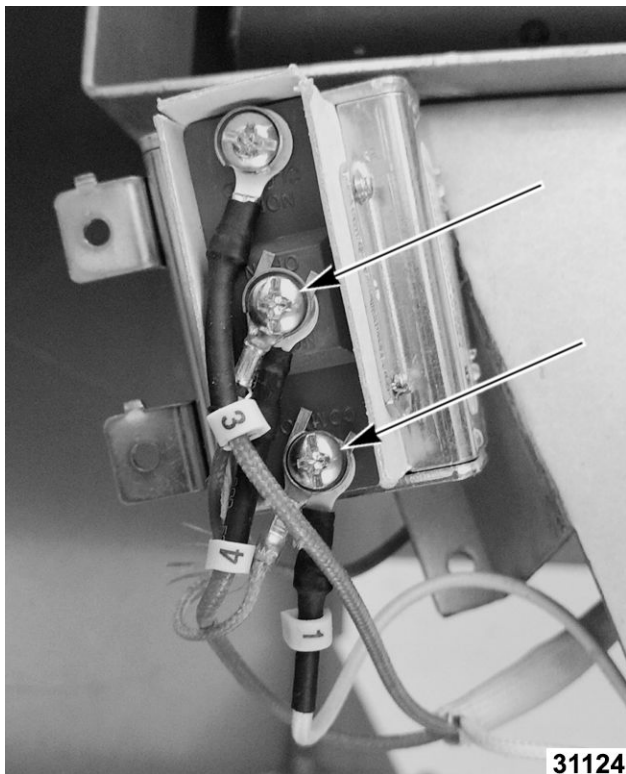

Fig. 16

- Loosen thermopile holding nut (1, Fig. 17).

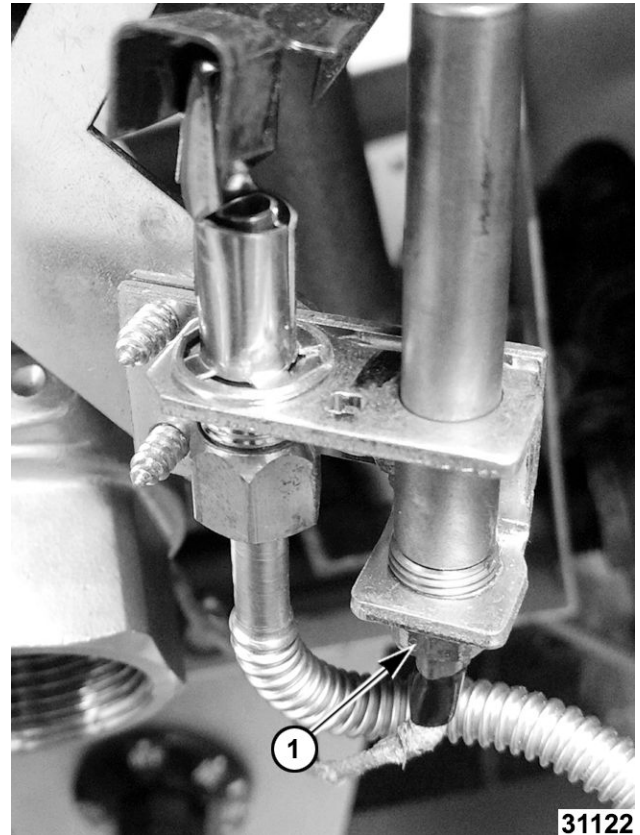

Fig. 17

- Remove thermopile from bracket.
- Reverse to install.

## PILOT



### ⚠ WARNING

Shut off the gas before servicing the unit and follow lockout / tagout procedures.

### ⚠ WARNING

All gas joints disturbed during servicing must be checked for leaks. Check with a soap and water solution (bubbles). Do not use an open flame.

- Remove HEAT SHIELD.
- Remove pilot assembly bracket.

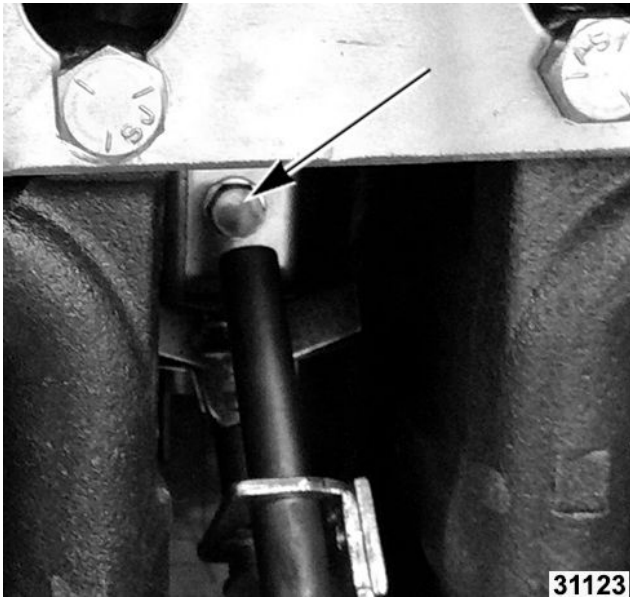

Fig. 18

3. Remove pilot nut at bottom of pilot assembly.

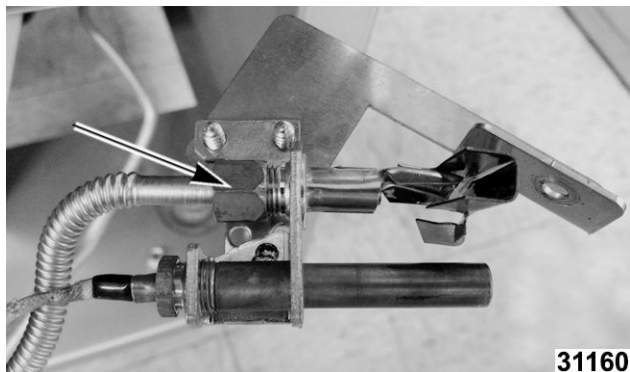

Fig. 19

4. Disconnect pilot tubing.
5. Remove THERMOPILE.
6. Remove pilot bracket screws.

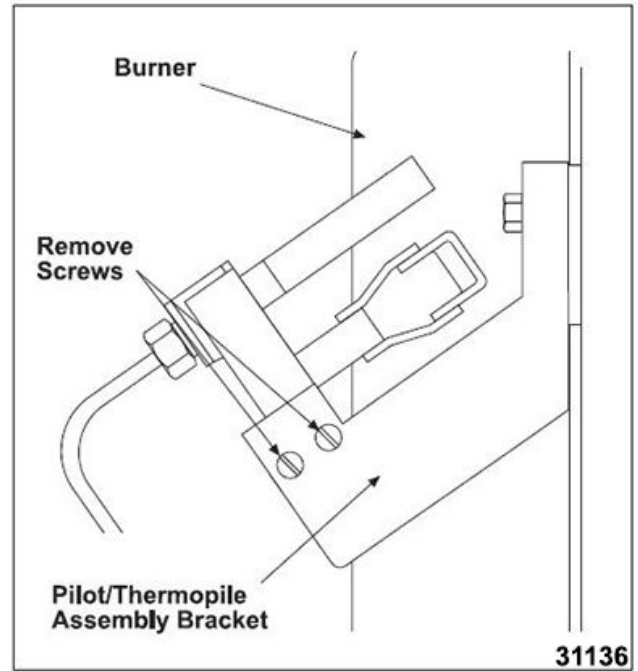

Fig. 20

7. Reverse procedure to install.

## PILOT ORIFICE



### **⚠ WARNING**

Shut off the gas before servicing the unit and follow lockout / tagout procedures.

### **⚠ WARNING**

All gas joints disturbed during servicing must be checked for leaks. Check with a soap and water solution (bubbles). Do not use an open flame.

1. Remove HEAT SHIELD.
2. Remove pilot assembly bracket.

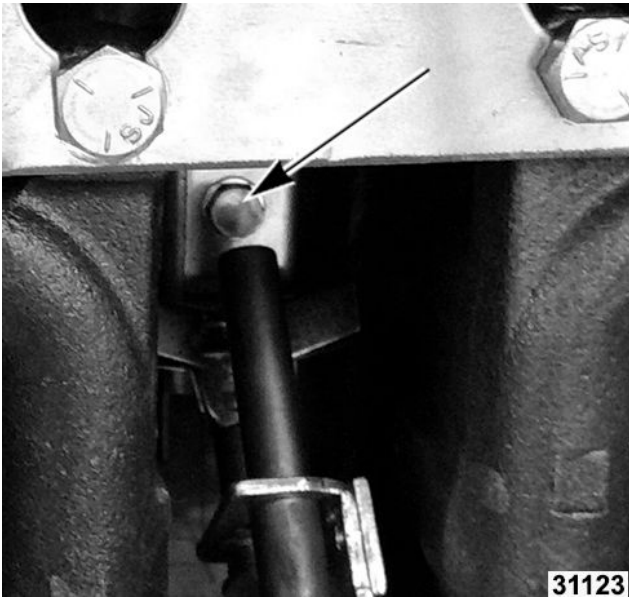

Fig. 21

- Remove the nut at bottom of pilot to expose the orifice.

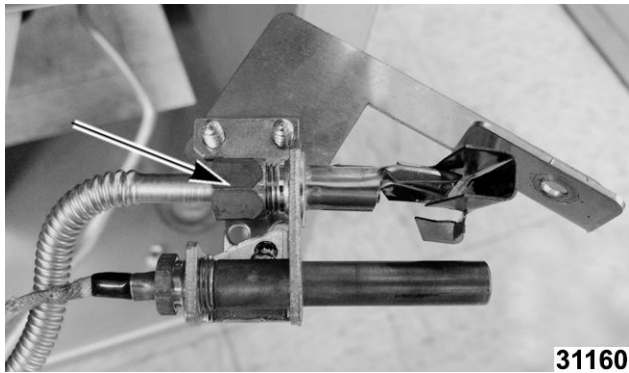

Fig. 22

- Pull orifice (1, Fig. 23) out and replace.

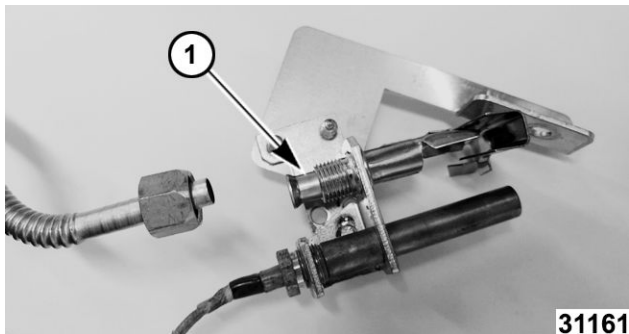

Fig. 23

- Reverse procedure to install.

## COMBINATION VALVE



### ⚠ WARNING

Shut off the gas before servicing the unit and follow lockout / tagout procedures.

### ⚠ WARNING

All gas joints disturbed during servicing must be checked for leaks. Check with a soap and water solution (bubbles). Do not use an open flame.

- Disconnect fryer from main gas supply.
- Remove RIGHT BURNER.
- Note and disconnect wires (1, Fig. 24) from combination valve (2, Fig. 24).

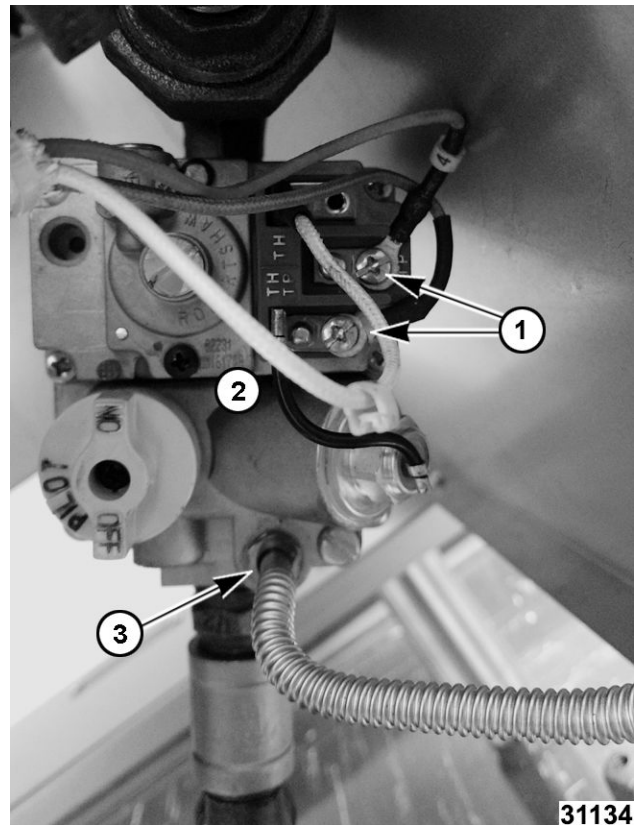

Fig. 24

- Disconnect pilot tubing (3, Fig. 24) from combination valve.
- Disconnect combination valve union and pressure fitting.

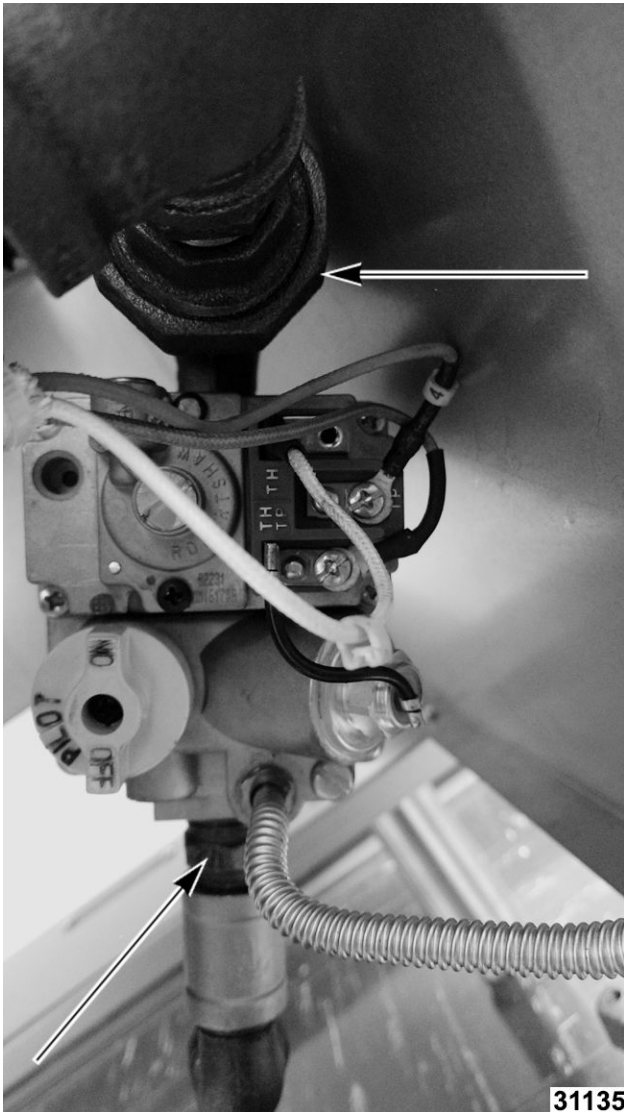

Fig. 25

6. Remove all pipe fittings from old valve if new valve is not supplied with fittings.
7. Reverse procedure to install.

## FRY TANK

### **⚠ WARNING**

Oil may be hot when draining fryer tank.



### **⚠ WARNING**

**Shut off the gas before servicing the unit and follow lockout / tagout procedures.**

1. Disconnect fryer from main gas line.
2. Remove all baskets, fryer basket hanger and crumb screen.

3. DRAIN FRYER TANK .
4. Remove HEAT SHIELD.
5. Remove FLUE WRAP.
6. Remove FLUE BOX.
7. Remove BACK PANEL.
8. Remove BURNERS and manifold bracket (Fig. 26).

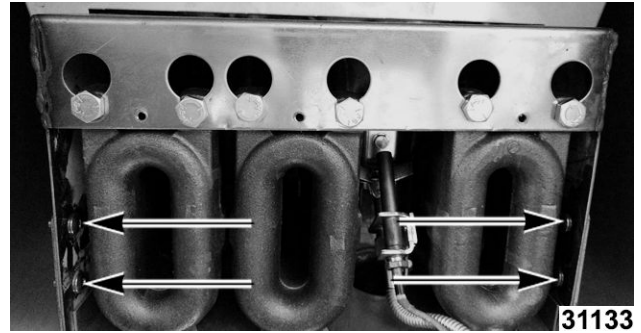

Fig. 26

9. Remove THERMOSTAT.
10. Remove HIGH LIMIT THERMOSTAT.
11. Remove pilot assembly bracket.



Fig. 27

12. Lift tank up and out of cabinet.
13. Remove drain valve from tank.
14. Reverse procedure to install.

# SERVICE PROCEDURES AND ADJUSTMENTS

## TURNING FRYER OFF

1. Turn thermostat off.



Fig. 28

2. Keep pilot lit by turning gas valve to the "L" in pilot.



Fig. 29

3. Turn gas valve to OFF position to shut gas off to the system, including pilot.

## LIGHTING PILOT

### NOTICE

Before lighting pilot make sure tank is filled with liquid shortening. Make sure gas supply to the fryer is on.

1. Turn thermostat off.



Fig. 30

2. Turn gas control valve knob to PILOT.
3. Wait five minutes for unburned gas to vent.
4. Push and turn the gas control valve to "L" in pilot.



Fig. 31

5. While still holding knob in, light the pilot with a flame. Continue to depress knob until pilot remains lit (approximately 30 seconds), then release knob.
6. Depress and turn gas control valve knob to ON.

**NOTE:** If gas supply is interrupted, repeat all steps.

## DRAIN FRYER TANK

### ⚠ WARNING

**Oil may be hot when draining fryer tank.**

1. Turn thermostat off.
2. Turn gas valve to "L" in PILOT to keep pilot lit.



**Fig. 32**

3. Place container under drain valve (1, Fig. 33) to drain shortening into.

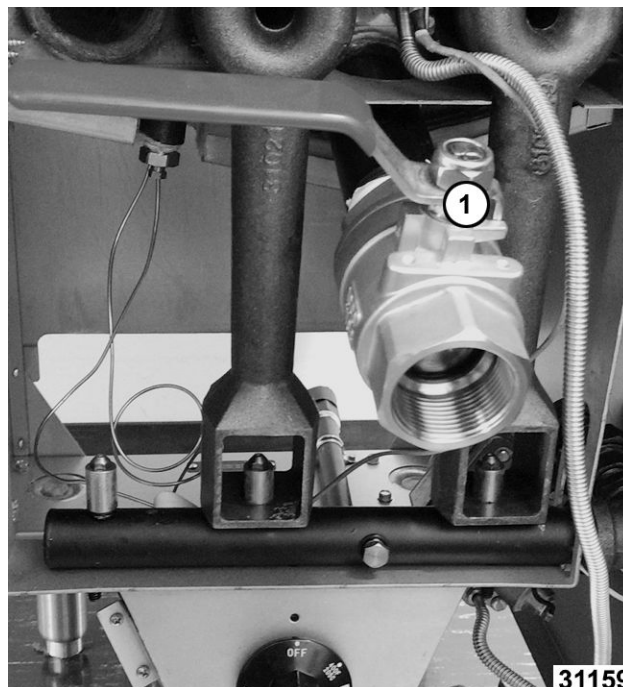

**Fig. 33**

4. Open the drain valve.
5. Close drain valve when fryer tank is emptied.

## MILLIVOLT CONTROLS TEST

1. Verify proper gas (natural or propane) is present.
2. Check for correct wiring and secure connections.
3. Verify pilot flame is adjusted properly as outlined in PILOT ADJUSTMENT.

**NOTE:** If the pilot is not lit, light pilot. Refer to: LIGHTING PILOT.

4. Allow pilot to burn for 3 to 4 minutes to stabilize.
  - A. If pilot remains lit, proceed to step 6.
  - B. If pilot will not remain lit, proceed to step 5.
5. Connect DC voltmeter to terminals TH-TP and TH of combination valve. Relight pilot, hold gas control valve knob in, and allow pilot to burn for 3 to 4 minutes to stabilize.
  - A. If voltage measures 450 millivolts or greater and pilot will not stay lit, replace combination valve.
  - B. If voltage is less than 450 millivolts, measure voltage at terminals NO and C of high limit.

**NOTICE**

If Voltage is 0 millivolts at high limit, remove red and white wires from high limit and check voltage with the pilot lit at the disconnected thermopile wires (red & white).

**NOTICE**

If you read voltage when thermopile wires are disconnected, but 0 volts connected to high limit, then the high limit is bad, and needs replaced.

- C. If voltage is less than 500 millivolts and more than 0, disconnect lead wire from terminal TH-TP on combination valve and remeasure voltage at the high limit.
  - If voltage is less than 500 millivolts, replace thermopile.
  - If voltage is 500 millivolts or more, replace combination valve.
- 6. Connect DC voltmeter to terminals TP and TH of combination valve.
- 7. Turn gas control valve knob to ON. Turn thermostat to a setting higher than the shortening temperature.
  - A. If voltage measures 150 millivolts or more but the burners do not ignite, replace combination valve.
  - B. If voltage is less than 150 millivolts, measure voltage between terminals NO on high limit and TP on combination valve.
    - If voltage is 200 millivolts or greater and burners do not light, replace thermostat.
    - If voltage is less than 200 millivolts and burners do not light, replace combination valve.

**THERMOSTAT CALIBRATION**

**⚠ WARNING**

Oil may be hot.

**NOTICE**

If oil is present, verify it is at proper fill mark.

**Check**

1. Place temperature tester in center of fry tank, one inch below the surface of the oil.
2. Set thermostat to 300°F and allow temperature to stabilize.

3. Check temperature tester reading against the thermostat dial reading. If there is a variance of more than +/- 20°F (280°F to 320°F), calibration is required.

**Calibration**

1. Remove thermostat knob from shaft.
2. Using a small screwdriver, rotate setscrew inside the hollow shaft counterclockwise to increase temperature or clockwise to decrease temperature (1/4 turn equals approximately 18°F).
3. Allow temperature to stabilize and recheck temperature. Repeat until the temperature falls within the limits as stated in step 3 under Thermostat Calibration - Check.
4. Install thermostat knob and set dial to 350°F
5. Allow temperature to stabilize at new setting and compare temperature tester to dial setting. Recalibrate if the temperature does not fall within the range of 330°F to 370°F.
6. If temperature does not fall within the limits at both settings, replace thermostat.
7. Seal the adjustment screw after calibration is complete.

**NOTE:** Glyptal or ordinary Nail polish is acceptable to use as sealant.

**PILOT ADJUSTMENT**

**NOTE:** Verify the proper gas type (natural or propane) is being supplied to fryer before proceeding.

1. Turn control thermostat to off.
2. LIGHT PILOT burner and leave gas combination valve knob/extension arm in pilot position.

**NOTICE**

Allow pilot to burn for 3-4 minutes to stabilize flame. If pilot burner is not lighting or does not remain lit when gas combination valve knob/extension arm is released, see TROUBLESHOOTING. Wait 5 minutes between pilot burner lighting attempts for unburned gas to vent.

**NOTE:** Connect meter to thermopile leads at high limit and monitor millivolt output, with pilot properly adjusted millivolt reading should be 500mV. increase or decrease pilot flame height to achieve 500mV.



- Verify flame does not extend beyond the outer edges of pilot shield  $\frac{1}{2}$ ", or extends more than  $\frac{1}{2}$ ", (Fig. 34). If adjustment is necessary continue with procedure.

**PILOT BURNER FLAME TARGET**

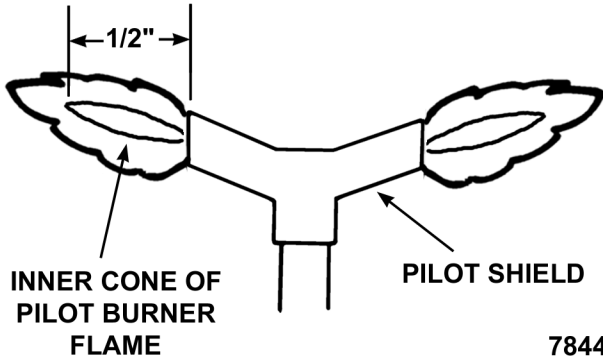

Fig. 34

- Remove the cap covering pilot adjustment screw from combination valve.

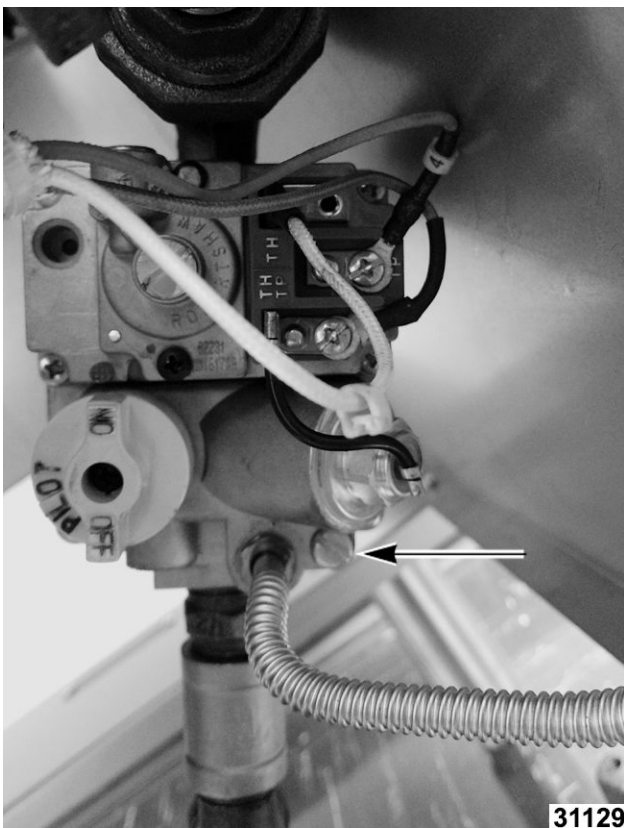

Fig. 35

- Turn counterclockwise to increase the size of flame.
  - Turn clockwise to decrease size of flame.
- Verify pilot burner is lit.

- Turn gas combination valve knob/extension arm to on and set control thermostat to call for heat.

**NOTICE**

If main burners do not light or pilot burner goes out, proceed to MILLIVOLT CONTROLS TEST.

**BURNERS, NOZZLES AND ORIFICES**



**WARNING**

Shut off the gas before servicing the unit and follow lockout / tagout procedures.

**Burners**

- Remove BURNERS.
- Check burners for cracks or clogged ports.

**NOTICE**

If burner ports become clogged fryer will not operate properly. If burner is cracked, it must be replaced.

- Wash burners in warm, soapy water.
- Hand-turn a drill bit into hole with obstruction as needed to remove blockage.

**Nozzles and Orifices**

- Remove BURNERS.
- Hold burner nozzle with channel locks and remove orifice.

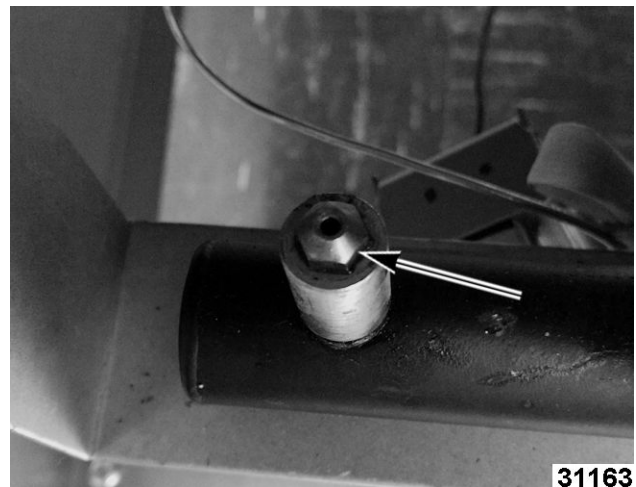

Fig. 36

- Check orifice for obstructions or damage.
- Wash orifice in warm, soapy water.

5. Clean orifice with an orifice cleaning tool. Remove obstruction as needed to remove blockage.
6. Reverse procedure to install new burner, nozzle and orifice.

## COMBINATION VALVE REGULATOR ADJUSTMENT



### ⚠ WARNING

**Shut off the gas before servicing the unit and follow lockout / tagout procedures.**

**NOTE:** Accurate gas pressure adjustments can only be made with gas on and burner lit. If incoming line pressure to valve is less than the minimum stated, then pressure cannot be set correctly.

Combination valve is preadjusted for natural or propane gas as specified on the rating plate. Natural gas rating is 4" W.C., and propane rating is 10" W.C.

1. Turn gas control valve knob to OFF.



**Fig. 37**

2. Remove plug from submanifold and install Manometer at this point.



**Fig. 38**

3. Turn on gas and LIGHT PILOT.
4. Turn gas control valve knob to ON.
5. Set thermostat so burners will come on.
6. Check pressure reading. Manifold Manometer should match pressure rating on data plate. Perform adjustment as necessary.

### Adjustment

- A. Remove adjustment screw cap.
- B. Turn adjustment screw (1, [Fig. 39](#)):

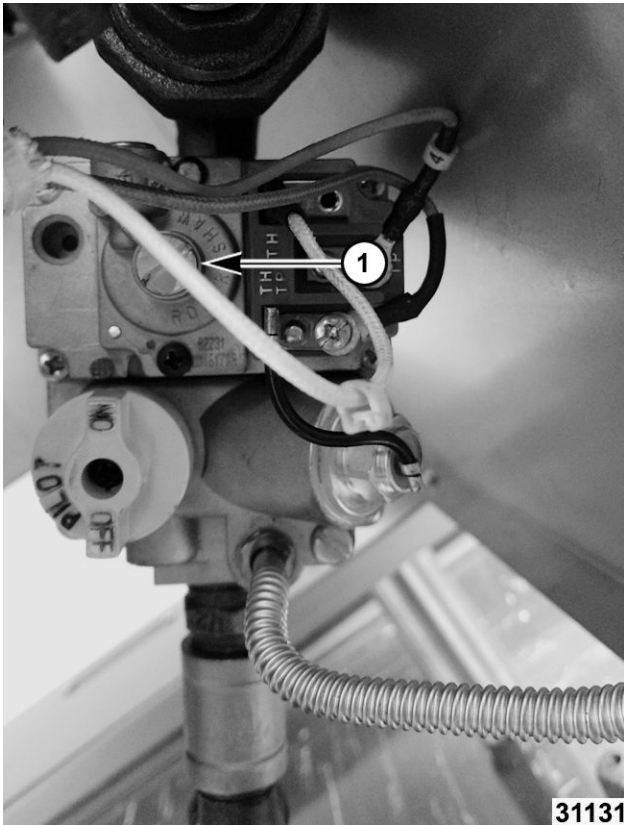

Fig. 39

- Counterclockwise to decrease pressure.
  - Clockwise to increase pressure.
7. Install cap and check for proper operation.

## EXTENDED SHUT-DOWN

### **⚠ WARNING**

**Oil may be hot.**

1. Turn thermostat off.
2. Push pilot knob in and turn to OFF.
3. DRAIN FRYER TANK .
4. Clean fryer.
5. Turn off main gas shutoff valve.



### **⚠ WARNING**

**Shut off the gas before servicing the unit and follow lockout / tagout procedures.**

# DIAGRAMS

## SCHEMATIC

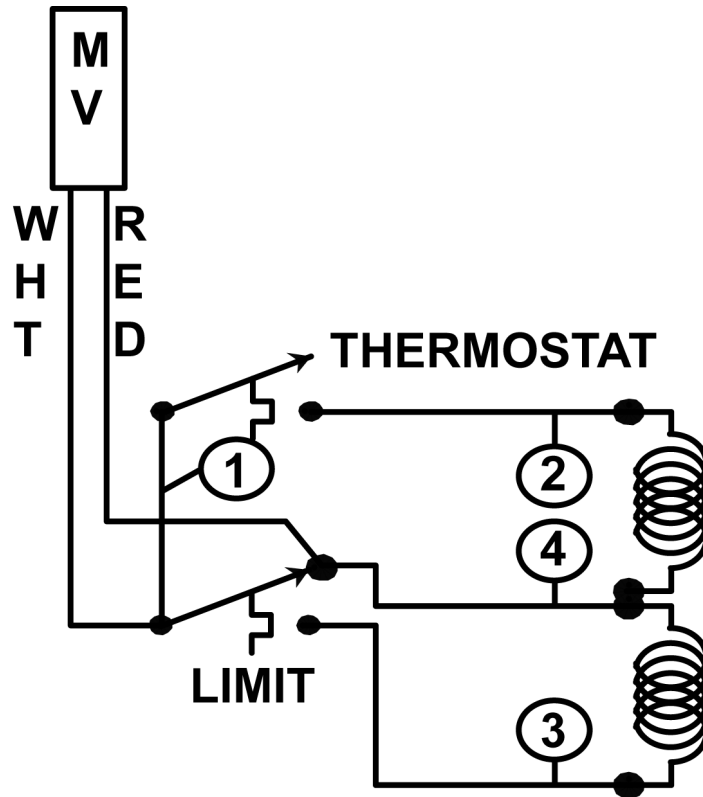

DERIVED FROM #958873

AI4735

Fig. 40

**NOTE:** High limit shown tripped.

**WIRING DIAGRAM**

**LG Series Gas Fryers**

Derived From  
427734 Rev D

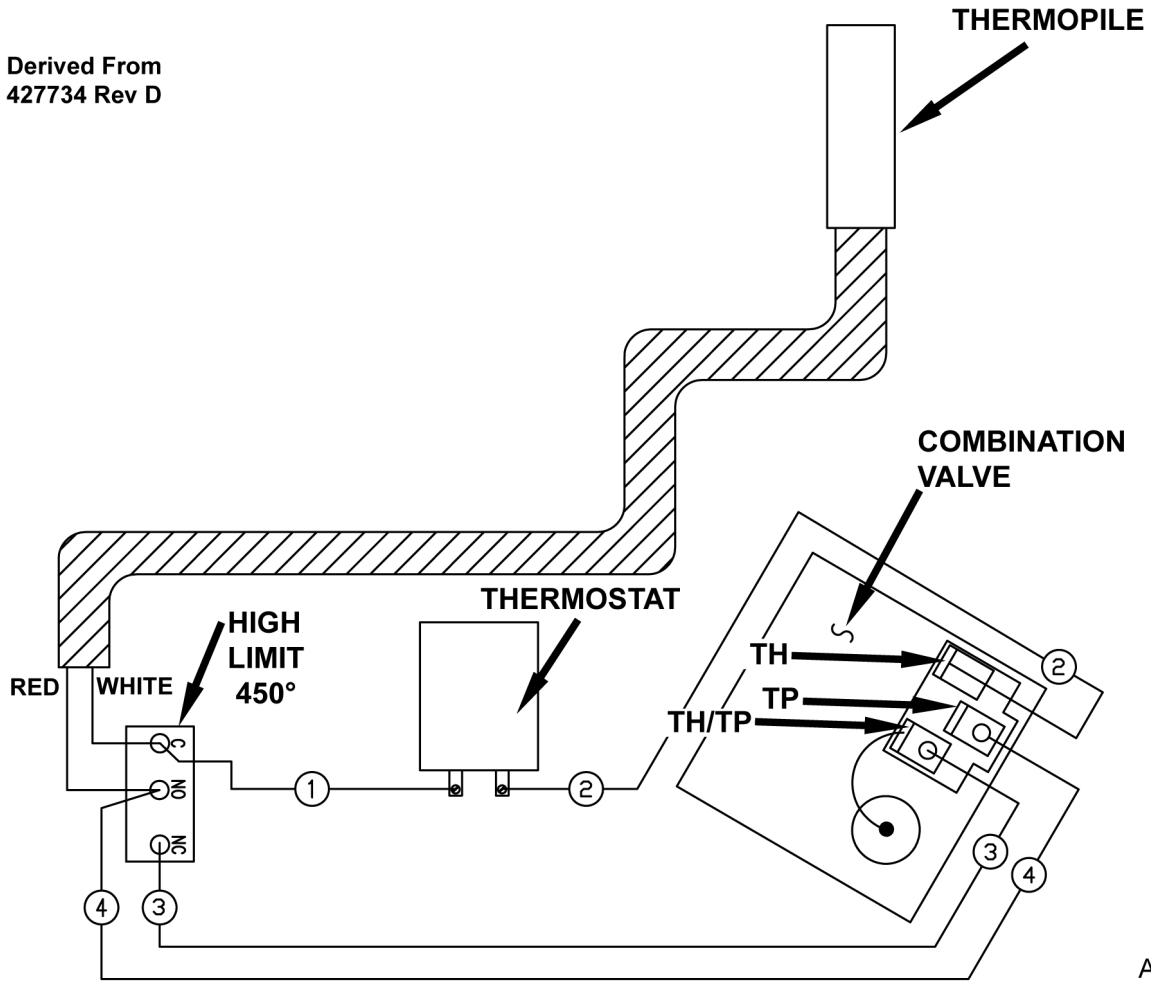

Fig. 41

AI4767

# ELECTRICAL OPERATION

## CONTROL SYSTEM DESCRIPTION

1. The thermopile (TH) provides total control voltage for this system.
  - A. One side of thermopile is connected to common (C) of high limit (HL).
  - B. The other side of the thermopile is connected to normally open (NO) contacts (wire 4) of high limit.
  - C. The common of high limit (below high limit trip temp) is connected through normally closed (NC) contacts of high limit, through wire 3 (wire 3 goes to TH/TP terminal on gas valve) to combination valve pilot connection common.
  - D. The other side of pilot valve is connected through wire 4 (wire 4 goes to NO terminal on high limit with red wire from thermopile) to wire 1 (wire 1 goes from thermostat to high limit common terminal with white wire from the thermopile) to high limit normally open contacts which hold pilot valve open.

**NOTE:** If high limit trips, connection is made from common to normally open contacts, turning off pilot valve voltage. The gas valve closes.

### 2. Thermostat Control

- A. One side of millivolt supply is connected through high limit system, as described above, to thermostat common (wire 2) of combination valve.
- B. The other side of thermopile is connected from normally open (common terminal on high limit) contacts of high limit to thermostat through wire 1 (common terminal on high limit).
- C. When the thermostat calls for heat (closed circuit) power from thermopile, it is then connected to other combination valve thermostat connection through wire 2 (to TH terminal on gas valve).
- D. If high limit trips, thermopile is connected across zero ohms, the output voltage of thermopile drops to 0.0 millivolts, and the thermostat coil of combination valve drops out, shutting the thermostat valve.

### 3. Total Shutdown

- A. When high limit trips, 0.0 millivolts will read across both coils of the combination valve, causing both valves to close.
- B. Pilot relight cannot be accomplished until oil cools sufficiently to allow high limit to close.
- C. If any wire in the system is shorting, cut or broken, the system will shut down.

## SYSTEM CONDITION QUICK CHECK PROCEDURE

1. Use the Pilot Lighting procedure and check millivolts (mV) at wires 3 and 4.
  - A. If the pilot lights, then pilot combination valve and high limit are good.
  - B. If the pilot will not stay lit, check high limit and open the thermopile circuit. It should read 500 mV; if there are Ø volts, check high limit. If the high limit is good, replace combination valve.
  - C. Check for voltage at disconnected thermopile. It should read 500 mV; if there are Ø volts, replace thermopile. Check high limit. If the high limit is good, replace combination valve.
2. Turn on thermostat; burners should light.
  - A. If burner does not light, check voltage at combination valve at wires 2 (TH) and 4 (TP).
  - B. If correct voltage is present, then check combination valve.
  - C. If there are Ø volts, check voltage between wire 3 of combination valve and wire 1 of thermostat. If correct voltage is present, then check resistance of the thermostat contacts and continuity of wires 3 & 2.

## COMPONENT FUNCTION

- Thermostat** ..... Millivolt type with capillary bulb, single-throw break on temperature rise. Temperature range of 200°F to 400°F.
- Thermopile** ..... Millivolt control with 24" capillary. Rated to generate 500 millivolts.
- Combination Valve** ... Regulates gas flow to burner and pilot. Provides pilot safety.
- High Limit** ..... Prevents overheating of fryer in the event of thermostat failure. Opens at 465°F and automatically resets at 415°F.

# TRUBLESHOOTING

## TRUBLESHOOTING

SYMPTOM	CAUSE	REMEDY
The temperature of shortening drops, or excessive recovery time is required.	<ol style="list-style-type: none"> <li>1. Insufficient gas supply to unit.</li> <li>2. Ventilation system pulling heat out of heat exchanger and flue box.</li> <li>3. Overloading fryer capacity.</li> <li>4. Check thermostat calibration and reaction times.</li> </ol>	<ol style="list-style-type: none"> <li>1. Adjust gas supply at gas combination valve.</li> <li>2. Relocate fryer.</li> <li>3. Adjust loads accordingly.</li> <li>4. Calibrate or replace thermostat.</li> </ol>
Pilot won't stay lit. Fryer shuts off.	<ol style="list-style-type: none"> <li>1. Malfunctioning thermopile or loose/dirty connection in thermopile.</li> <li>2. Gas supply turned off or disconnected.</li> <li>3. Pilot burner orifice and air openings need cleaning.</li> <li>4. Possible shorted combination valve.</li> <li>5. High limit is open.</li> </ol>	<ol style="list-style-type: none"> <li>1. Check thermopile function and connections. Adjust or replace as required.</li> <li>2. Clean burner orifice and air openings as required.</li> <li>3. Check each post on combination valve to ground. If zero resistance, replace combination valve.</li> <li>4. Check high limit, are NC contacts open?</li> </ol>
Rapid shortening breakdown, crumbs and specks in frying compound.	<ol style="list-style-type: none"> <li>1. Excessive temperature settings (over 375°F).</li> <li>2. Shortening not being filtered regularly.</li> <li>3. Incorrect preparation of breaded food.</li> </ol>	<ol style="list-style-type: none"> <li>1. Adjust temperature setting.</li> <li>2. Adjust filtering schedule.</li> <li>3. Do not use salt.</li> <li>4. Allow breading time to adhere to food.</li> <li>5. Do not allow loose flour to fall into shortening from hands.</li> <li>6. Do not add straining or drippings from meat fats to shortening.</li> <li>7. Use correct shortening and follow temperature recommendations.</li> <li>8. Take out 10% to 15% of the shortening.</li> <li>9. Check thermostat settings with thermometer periodically.</li> </ol>



SYMPTOM	CAUSE	REMEDY
Leaking tank.	<ol style="list-style-type: none"> <li>1. Foam-over by depleted shortening permits oil to drip from the tank surface, giving appearance of leaking.</li> <li>2. Careless draining procedures.</li> <li>3. Carbon buildup causes rapid attack on tank by promoting acid formulation.</li> </ol>	<ol style="list-style-type: none"> <li>1. Replace shortening.</li> <li>2. Gas control valve knob should be in PILOT or OFF position before draining oil. Burners heating an empty tank will damage tank joints.</li> <li>3. Clean tank surfaces.</li> </ol>
Pilot burner flames adjusted properly, but fluctuates to very low and blows out easily.	<ol style="list-style-type: none"> <li>1. Gas pressure too low.</li> <li>2. Gas pressure too low at submanifold.</li> </ol>	<ol style="list-style-type: none"> <li>1. Check gas pressure on submanifold fitting when fryer is in operation.</li> <li>2. Check other equipment attached to same gas line.</li> <li>3. Adjust gas pressure at submanifold to not less than 4.0" W.C. (natural and mixed gas) or 10.0" W.C. for propane gas.</li> </ol>